

~15 kg

Fixe
(1 : 10)

Zoom
(1 : 10)

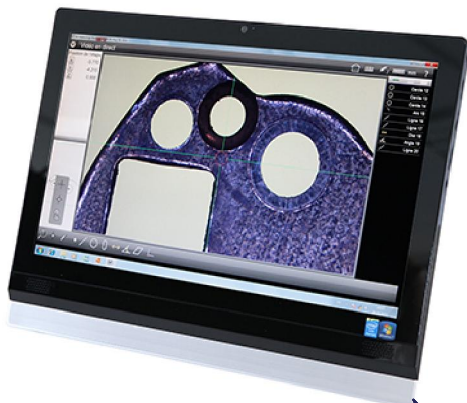
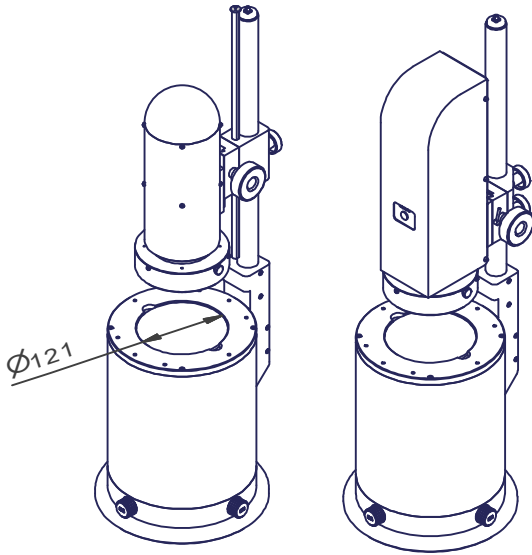

All In One 24"
~11kg

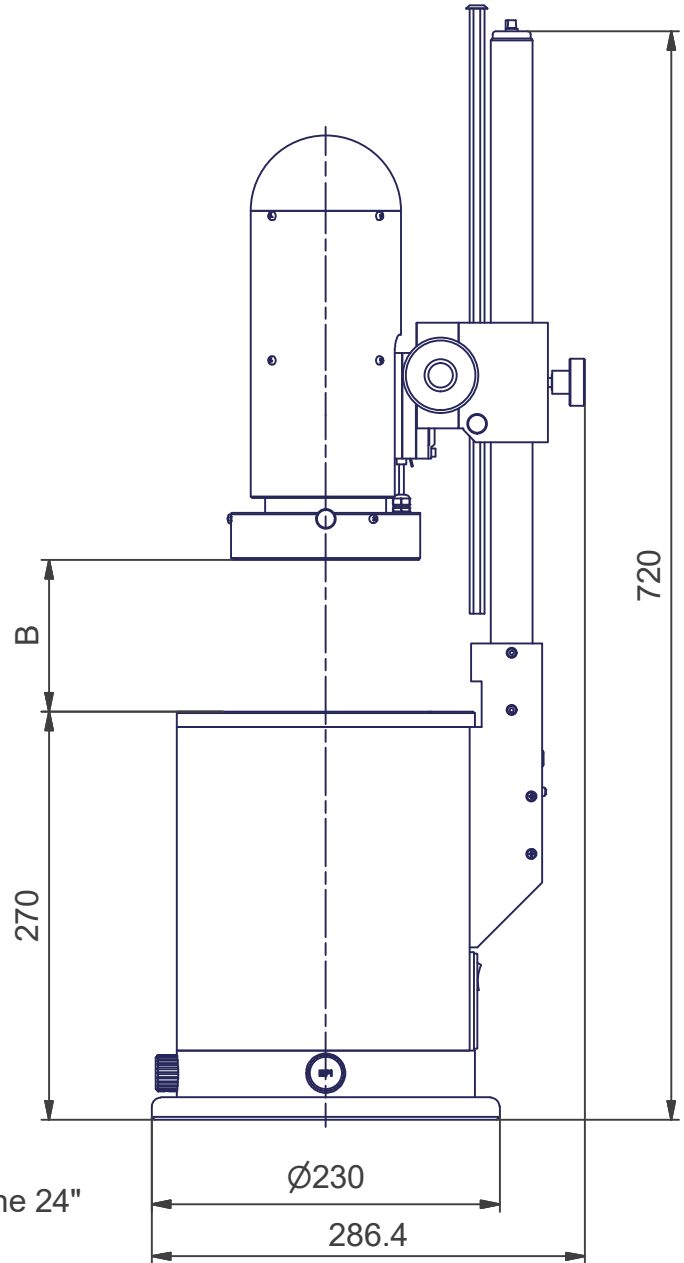

Code dispositif VideoRET	Code dispositif M3E FOV	Type	(h) x (v)	B	Prof. champ	Grossissement
DCV-020828	DCV-020832	MA 152-244-21	5.6 x 4.2	59.3	0.9	70X
DCV-020829	DCV-020833	MA 152-244-22	10.6 x 8.0	41.3	2	37X
DCV-020830	DCV-020834	MA 152-244-23	23.1 x 17.3	103.5	11	17X
DCV-020831	DCV-020835	MA 152-244-24	49.3 x 37.0	147.3	51	8X
DCV-021083	DCV-021482	MA 152-244-28	22.8 x 17.1 à 2.8 x 2.1	74	11 à 0.2	130X à 16X
DCV-021084	---	MA 152-244-29	45.6 x 34.2 à 5.7 x 4.2	157.8	45 à 0.7	65X à 8X

Mod. 1		Mod. 3		Origine		Echelle	Nom
Mod. 2		Mod. 4		Rempl.		1:5	M.Saam
Libellé				N° de plan		Date	
Titan View				MA 152-244-2...		20.01.2014	
marcel - aubert - sa						Code article	N° de page
						DCV-...	1 / 3

OPTIONS MECANQUES			VARIANTES					INFORMATIQUE		
Outils axes X ou Y ou XY			Blocs optiques					Hardware		
Code	Type	Description	Code	Type	(h) x (v)	B	Prof. champ	Code	Type	Description
ACS-017532	MA 690-027	Plateau glissant = ±15	DCV-020606	MA 152-244-31	5.6 x 4.2	59.3	0.9	MCA-018213	MCA-190-422	PC - écran All in one 24"
TAB-020622	MA 152-244-82	XY = 50x50	DCV-020607	MA 152-244-32	10.6 x 8.0	41.3	2			
DEP-021314	MA 153-043-03	X ou Y = 75	DCV-020608	MA 152-244-33	23.1 x 17.3	103.5	11			
			DCV-020609	MA 152-244-34	49.3 x 37.0	147.3	51			
			DCV-021062	MA 152-244-42	22.8 x 17.1 à 2.8 x 2.1	74	11 à 0.2			
			DCV-021082	MA 152-244-41	45.6 x 34.2 à 5.7 x 4.2	157.8	45 à 0.7			
Outils axe R			Base					Software		
Code	Type	Description	Code	Type	Description		Code	Type	Description	
OTA-020621	MA 152-244-81	Rotation sur vés	BAS-021220	MA 152-244-14	Base pour VideoRET		LOG-020536	LOG-003-40	Logiciel VideoRET	
OTA-020624	MA 152-244-83	Rotation sur rouleaux	BAS-021444	MA 152-244-13	Base pour M3E FOV		MCA-021499	MCA-190-311	Calculateur M3E FOV	
OTA-020625	MA 152-244-84	Diviseur								

Composition à minima

MA 153-043-03
Axe 75 X ou Y
CF page 3

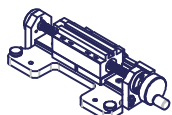

MA 152-244-84
Diviseur

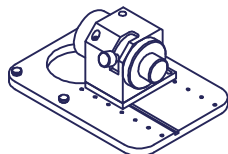

MA 152-244-83
Rotation sur rouleaux

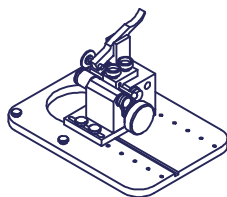

MA 152-244-82
Table 50x50

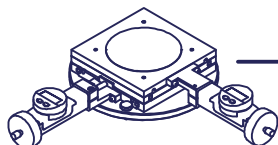

MA 152-244-81
Rotation sur vés

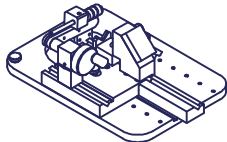

MA 690-027
Plateau glissant



MA 152-244-31
MA 152-244-32
MA 152-244-33
MA 152-244-34
Bloc optique
fixe

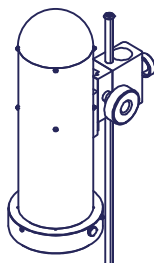

MA 152-244-42
MA 152-244-41
Bloc optique
zoom

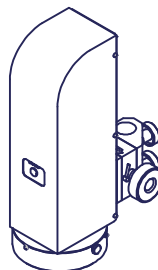

MA 152-244-14
MA 152-244-13
Base

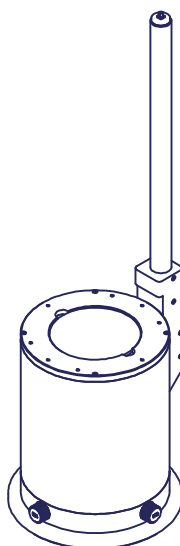

MCA-190-422
All in one 24"



LOG-003-40
VideoRET



MCA-190-311
M3E FOV



Mod. 1		Mod. 3		Origine		Echelle	Nom	M.Saam
Mod. 2		Mod. 4		Rempl.		1:10	Date	20.01.2014
Libellé				N° de plan		Catégorie		
Titan View				MA 152-244-2...		\$20-0		
marcel - aubert - sa						Code article		N° de page
						DCV-...		2 / 3

MA 153-043-10
OTA-020783
Entre-pointes
mobiles

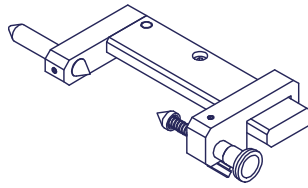

MA 153-043-11
OTA-020801
Vés mobiles

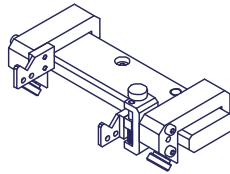

MA 153-043-12
OTA-020802
Chuck mobile

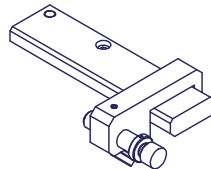

MA 143c
OTA-008027
Vé

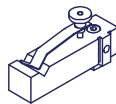

MA 143b
OTA-008011
Pince angulaire

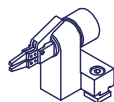

MA 143b-001
OTA-008014
Pince parallèle

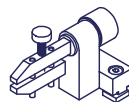

MA 153-043-03
DEP-021314
Axe 75 X ou Y

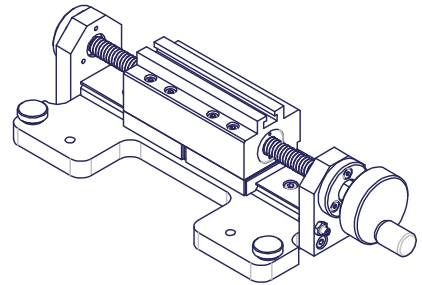

Mod. 1		Mod. 3		Origine		Echelle	Nom	M.Saam
Mod. 2		Mod. 4		Rempl.		1:4	Date	20.01.2014
Libellé				N° de plan		Catégorie		
Titan View				MA 152-244-2...		\$20-0		
marcel - aubert - sa 						Code article	N° de page	
						DCV-...	3 / 3	